

NANLITE

PavoSlim 60B LED Bi-color Panel Light

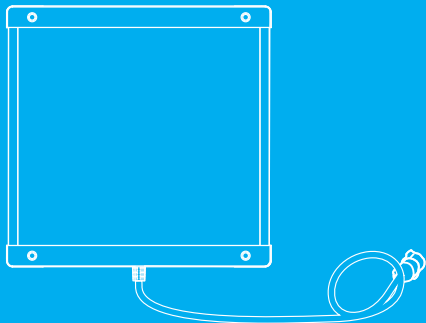

USER MANUAL

Introduction

Thank you for purchasing Nanlite product -- PavoSlim 60B!

The bi-color slim panel light is designed for content creators and commercial shooting teams. It possesses color temperature ranging from 2700K to 6500K (promptly toggle between common used CCT by short press) and 12 effects. The parameters of each effect is fully tunable for more creation possibilities. It provides multiple power options by equipped with AC socket, NP-F and V-mount battery holder, together with control methods of on-board, Nanlink App and DMX/RDM, meets the control requirement from basic to professional-grade. The included softbox, diffuser and eggcrate will further unleash users' creativity.

With slim and lightweight fixture body of 1×1" size, PavoSlim 60B is particularly suitable for small space, run & gun situations, providing a great help on content creation, commercial, film and television production lighting setup.

Notice

1. Please do not look directly at the emitter when the fixture is on.
2. Please do not place any object on the fixture or allow liquid to flow inside the fixture.
3. Please do not place the fixture near any flammable or volatile substances like alcohol or gasoline.
4. Please do not use strong detergent for cleaning. Please wipe off the dirt by using a cloth with neutral cleanser when cleaning the fixture.
5. Please set up the fixture in a dry and well-ventilated place. Please do not use it in any humid, dusty or overheated environment. Meanwhile, please also check whether the fan and vent are unimpeded.
6. Please do not disassemble the fixture to repair at will. Qualified professionals should conduct maintenance under the condition of strictly following the operating procedures described in this manual.
7. Please do not cover the vents when using, to avoid affecting heat dissipation, and resulting in damage. Please pay attention to anti-scald when using the fixture for a long time, since the surface temperature of fixture will be high.

PavoSlim 60B LED Bi-color Panel Light

■ Product Diagram

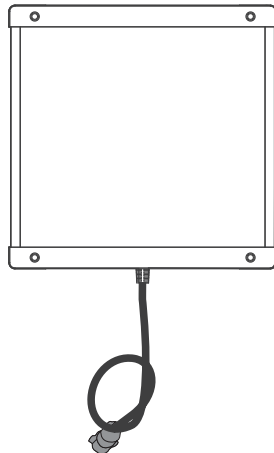

■ Technical Data

Rated Power: 72W

Input: DC (Battery) 14.4-26V

DC (Battery) 7.4V×2

AC100-240V 50/60Hz

Color Temperature: 2700K-6500K

CRI: Average 95

TLCI: Average 97

Product Details

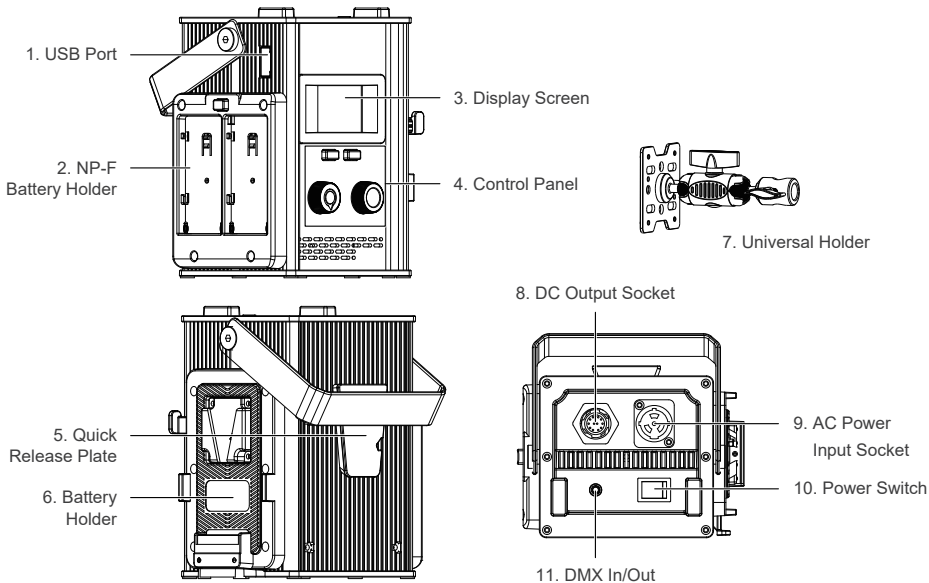





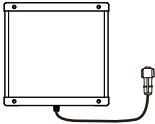
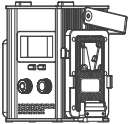

Detailed Description

1. USB Port: For updating firmware.
2. NP-F Battery Holder: For mounting the NP-F batteries.
3. Display Screen: For displaying datas.
4. Control Panel: For displaying various function operations and datas.
5. Quick Release Plate: For mounting the quick release clamp.
6. Battery Holder: For mounting the V-mount battery.
7. Universal Holder: For securing the fixture body and adjusting to any angle.
8. DC Output Socket: To connect the DC cable for connecting between the fixture body and control unit.
9. AC Power Input Socket: To connect the AC power cable to power the control unit.
10. Power Switch: To turn on/off the fixture.
11. DMX In/Out: Connect to DMX adapter cable for DMX signal input and output.

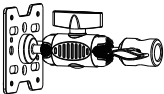
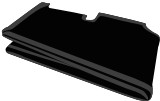
(Note: DMX adapter cable is sold separately).

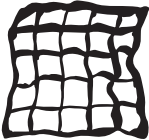
Includes

PavoSlim 60B x 1	Control Unit x 1	DC Connection Cable x 1	AC Power Cable x 1
			
Universal Holder x 1	Softbox x 1	Diffuser x 2	Eggcrate x 1
			
Carrying Bag x 1	User Manual x 1		
			

Usage

1. Connection Between Light Fixture, Control Unit and Power Supply.

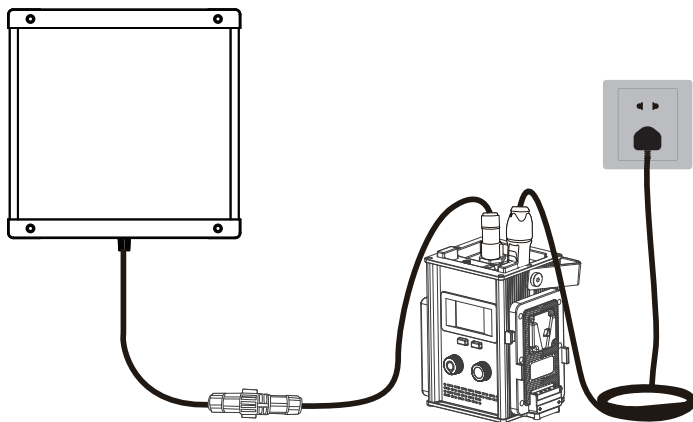

Note:

- 1.1. When connecting the power supply, please make sure the power voltage is consistent with that indicated on the control unit.
- 1.2. Make sure to use the included AC power cable and control unit. The connection between the DC output socket and the DC connection cable from the fixture body should be done as shown above.

2. Connection Between Light Fixture and Control Unit with Battery

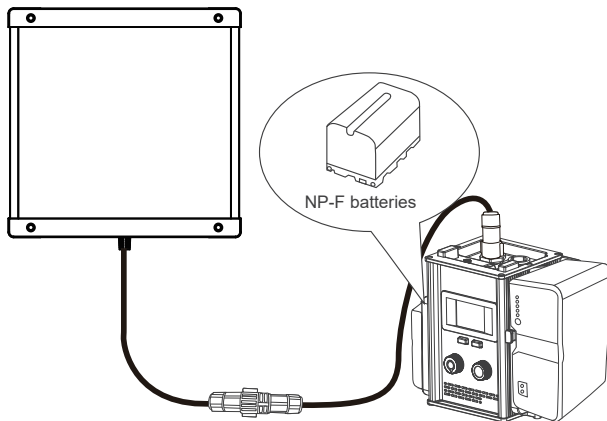

Turn off the power switch before installing the battery on the battery holder of the control unit.

Note:

- 2.1 Please do not exert too much force when mounting the battery, to avoid damage and deformation of the battery holder.
- 2.2 Please press the battery lock catch when removing the battery, to avoid damage of the battery holder.
- 2.3 NP-F battery holder is for mounting NP-F batteries.
- 2.4 V-mount battery holder is for mounting 14.4-14.8V or 26V V-mount batteries.

3. Installation and Detachment of Quick Release Clamp (optional purchase)

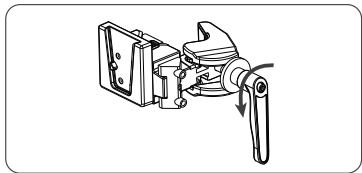

Rotate the adjustable handle to release the clamp.

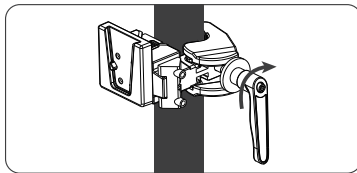

Mount the quick release clamp on the light stand, then rotate the adjustable handle to tighten the clamp.

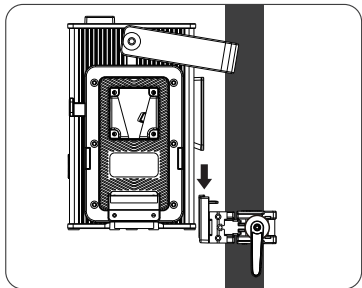

Align the quick release plate on the control unit with the quick release mount on the clamp to mount the control unit on to the clamp.

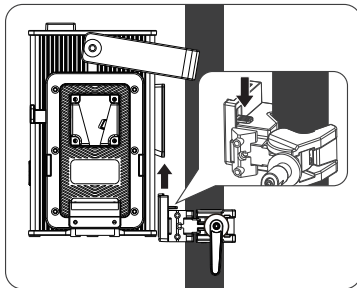

Press the lock catch on the clamp to remove the control unit from the light stand.

4. Installation of Softbox and Diffuser

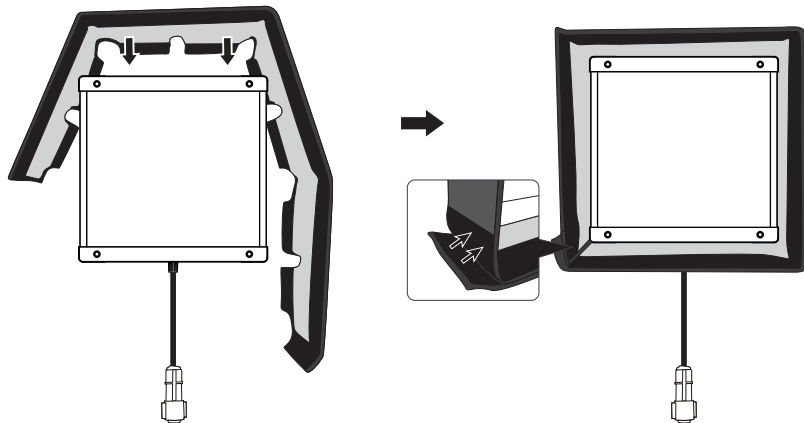

4.1. Unfold the softbox, wrap the softbox around the fixture body and stick at the interface.

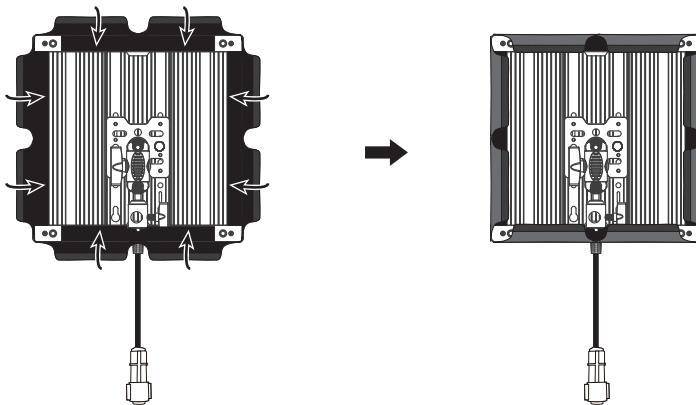

4.2 Attach the hook and loop fasteners on the back of softbox to the back of the fixture.

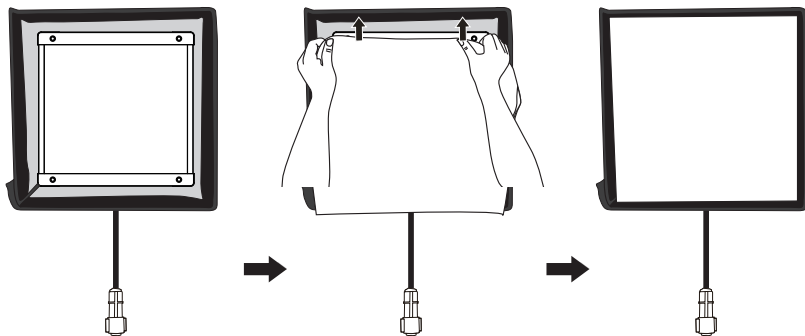

4.3 Attach the diffuser to the black hook and loop fasteners on the inside of the softbox.

Note: There are included two diffusers: lite diffuser and standard diffuser.

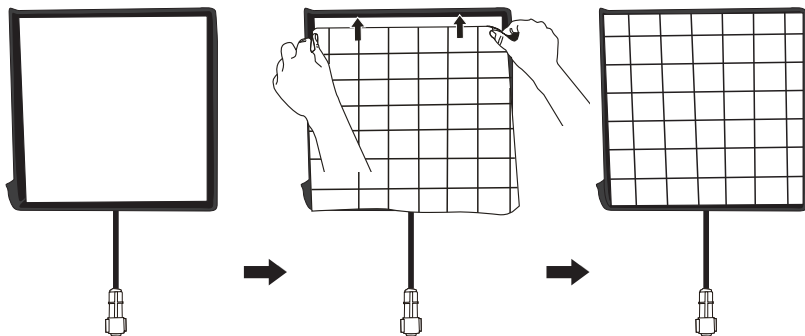

4.4 Attach the eggcrate to the hook and loop fasteners on the inside of the softbox.

5. Installation and Detachment of Universal Holder

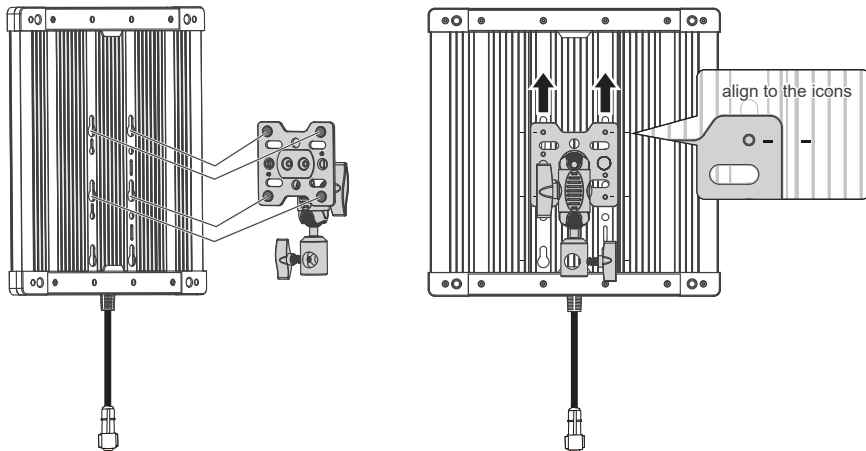

5.1 Align to the icons that on the back of fixture and follow the direction shown as the picture to install the universal holder.

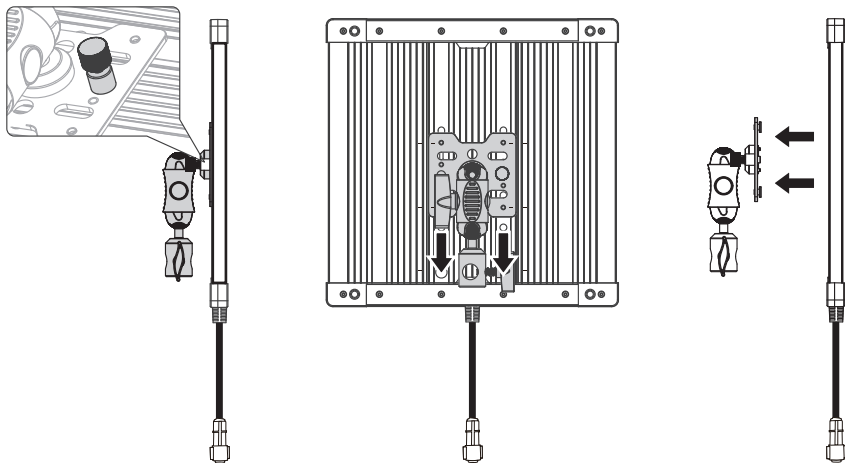

5.2 Pull up the knob of the universal holder, and slide the universal holder in the direction shown as picture above to remove it from the fixture.

Remote Control

PavoSlim 60B supports DMX/RDM and 2.4G remote control, and it also has built-in Bluetooth module.

▲ The address needs to be set before operating the remote control via DMX/RDM and 2.4G.

1. ADDRESS/DMX Setting, including ADDRESS, DMX MODE, DMX REDUCED CHANNELS, DMX DIMMING CURVE and DMX SMOOTHING.

1.1 ADDRESS Setting

Press the MENU button to enter the menu.

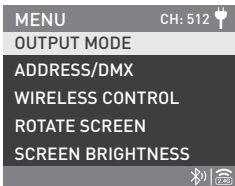

Left Knob



Right Knob



MODE



MENU

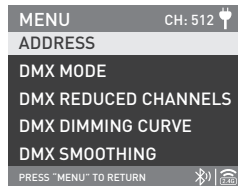
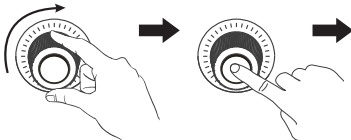
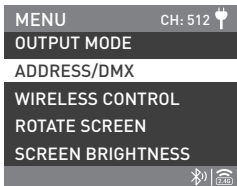

Rotate the right knob to ADDRESS/DMX, and press the right knob to enter the secondary menu.

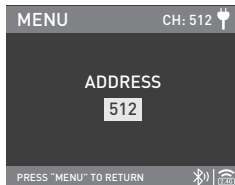
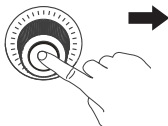
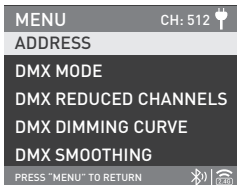

Rotate the right knob to ADDRESS, and press the right knob to enter the tertiary menu.

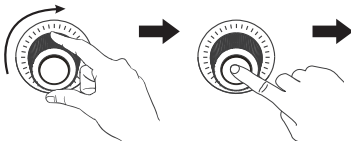
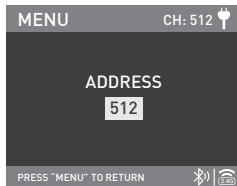

Rotate the right knob to select needed address, and press the right knob to set.

Note: PavoSlim 60B has 10 channels, for multiple lights remote control via DMX/RDM, the address of the first light fixture should be set to 001, the second one to 011, the third one to 021, and so on.

1.2 DMX MODE

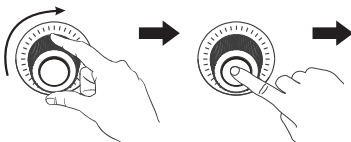
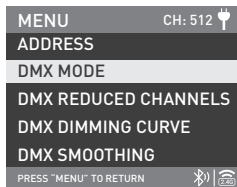

Rotate the right knob to DMX MODE, and press the right knob to enter the tertiary menu.

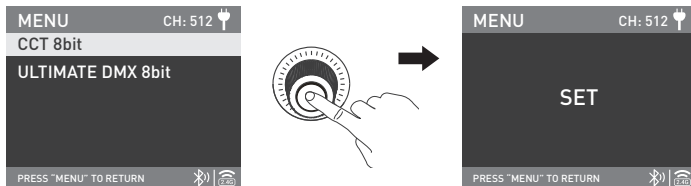

Rotate the right knob to select CCT 8bit or ULTIMATE DMX 8bit, and press the right knob to set.

1.3 DMX REDUCED CHANNELS

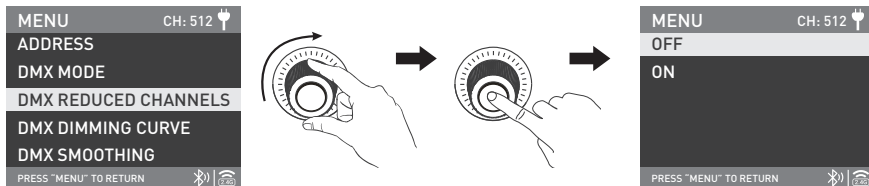

Rotate the right knob to DMX REDUCED CHANNELS, and press the right knob to enter the tertiary menu.

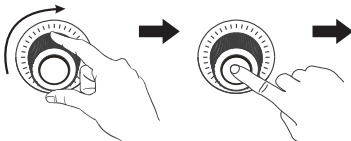
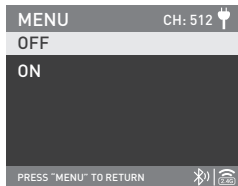

Rotate the right knob to select ON or OFF, and press the right knob to set.

1.4 DMX DIMMING CURVE

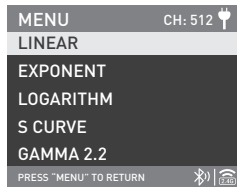
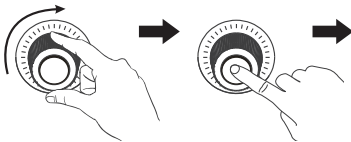
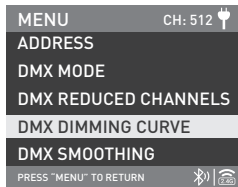

Rotate the right knob to DMX DIMMING CURVE, and press the right knob to enter the tertiary menu.

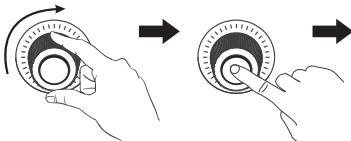
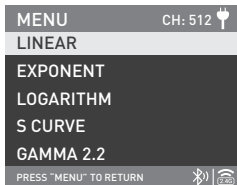

Rotate the right knob to select LINEAR, EXPONENT, LOGARITHM, S CURVE or GAMMA 2.2, and press the right knob to set.

1.5 DMX SMOOTHING

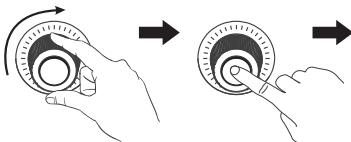
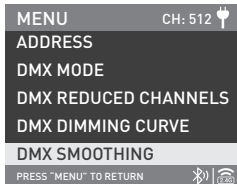

Rotate the right knob to DMX SMOOTHING, and press the right knob to enter the tertiary menu.

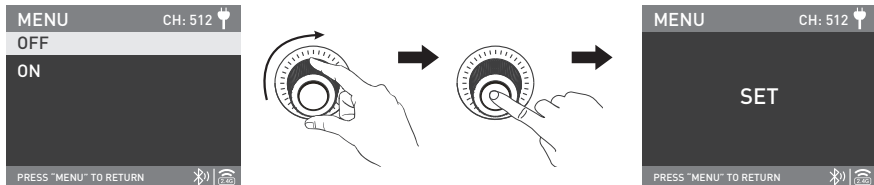

Rotate the right knob to select ON or OFF, and press the right knob to set.

2. DMX Control

2.1 Connect the fixture to the DMX/RDM consoles via DMX cable as shown below:



·5-pin shielded cable with a diameter not less than 0.3mm must be used for connection between light fixture and DMX/RDM console, or between light fixture and light fixture. XLR plug/socket and the cable should be connected as shown above.

·Pin1, Pin2, Pin3 for connecting DMX signal. Pin4, Pin5 have no connection.

▲NOTE: When connecting DMX, make sure the internal pin is not in contact with the inner case, and pins should not be in contact with each other.

The fixture can match the DMX512 (1990) control signal.

·5-pin and 3-pin XLR plug/socket conversion

The fixture comes with 5-pin XLR plug/socket. If a 3-pin XLR plug is used, please follow the instruction below.

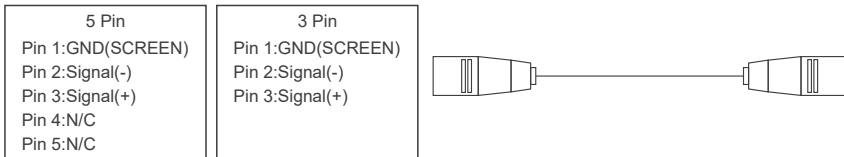

2.2 DMX Terminator

In DMX control mode, the DMX output of the last light fixture should be connected with a DMX terminator (not included).

The terminator is connected with a 120Ω(OHM) resistor across Pin 2 and Pin 3 (As shown below).

This prevents interference caused by DMX signals in the transmitting process.

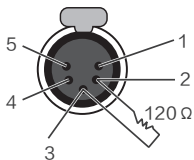

DMX Terminator Connection
Connect a 120Ω(OHM) resistor
across Pin 2 and Pin 3 in an XLR
plug and insert into the DMX
OUT socket on the last unit.

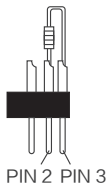

2.3 Address Setting of the Light Fixture.

2.4 Refer to the DMX reference guide and control the fixture via DMX/RDM console.

(For detailed operation please refer to the DMX/RDM console operation manual.)

2.5 The latest technical data can be download from www.nanlite.com.

3. RDM Control

3.1 Connect the light fixture to the console with RDM function by using a connection cable, the connecting method is the same as that of DMX/RDM console.

3.2 Control the fixture via a console with RDM function. (For specific operation methods, please refer to the RDM console operation manual.)

Note: The UID format of the fixture is as follow:

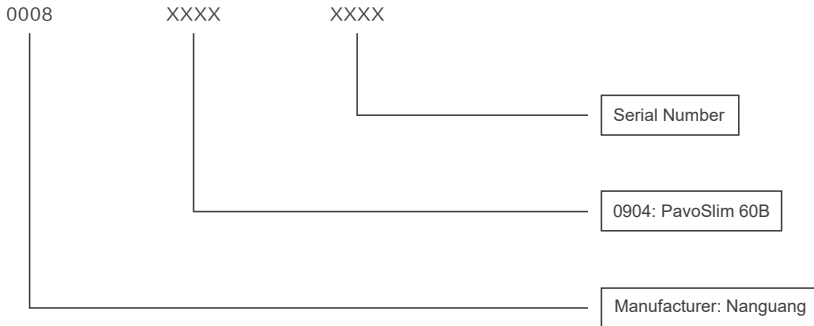

4. WIRELESS CONTROL

4.1 Bluetooth Setting

PavoSlim 60B has built-in Bluetooth function for connection via Bluetooth.

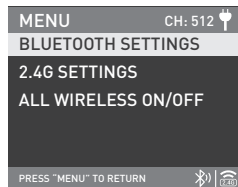
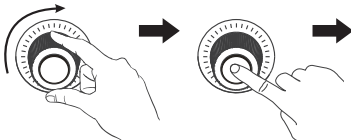
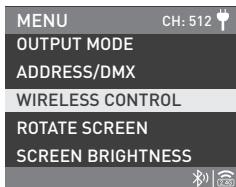

Rotate the right knob to WIRELESS CONTROL, and press the right knob to enter the secondary menu.

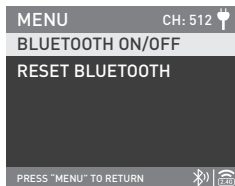
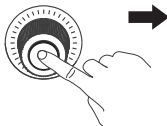
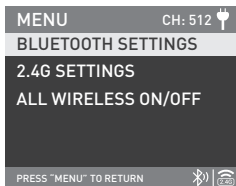

Rotate the right knob to BLUETOOTH SETTINGS, and press the right knob to enter the tertiary menu.

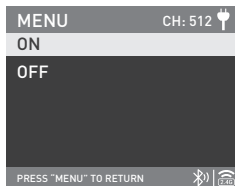
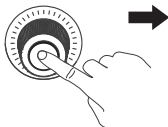
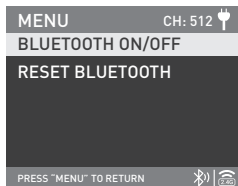

Rotate the right knob to BLUETOOTH ON/OFF, and press the right knob to enter the next menu.

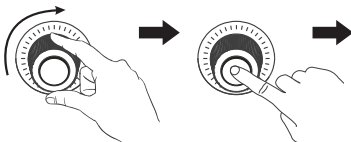
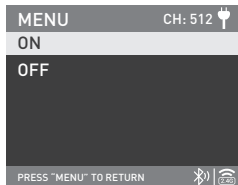

Rotate the right knob to select ON or OFF, and press the right knob to set.
The RESET BLUETOOTH is available when the Bluetooth is on.

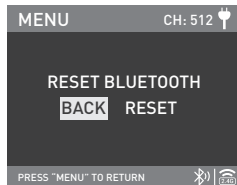
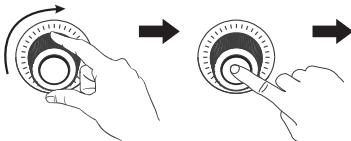
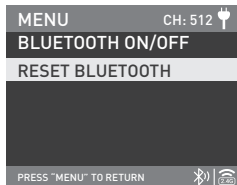

Rotate the right knob to **RESET BLUETOOTH**, and press the right knob to enter the next menu.

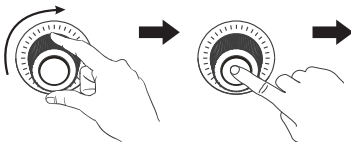
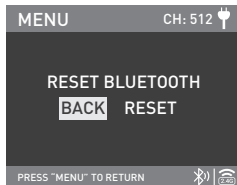

Rotate the right knob to **RESET**, and press the right knob to set.

4.2 2.4G Setting

PavoSlim 60B can be remotely controlled by 2.4G remote controller or by Nanlink App via the WS-TB-1 transmitter box.

Note: ①2.4G remote controller and WS-TB-1 transmitter box are sold separately.

②PavoSlim 60B supports the 2.4G wireless protocol V1.0 and V2.0. The fixture should be set in V2.0 while using WS-RC-C2 remote controller, set in V1.0 while using other remote controllers.

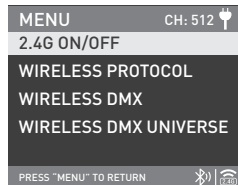
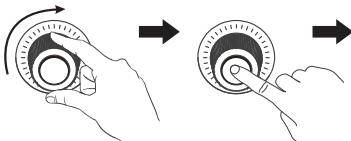
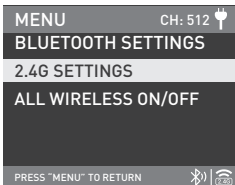

Rotate the right knob to 2.4G SETTINGS, and press the right knob to enter the tertiary menu.

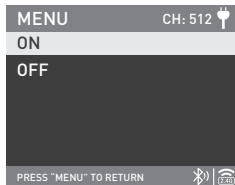
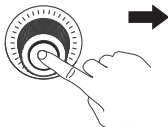
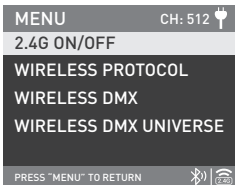

Rotate the right knob to 2.4G ON/OFF, and press the right knob to enter the next menu.

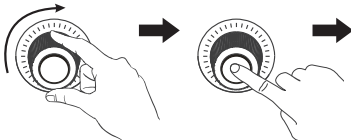
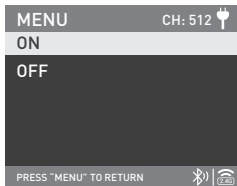

Rotate the right knob to select ON or OFF, and press the right knob to set. The 2.4G wireless control is available when the 2.4G is set to be on.

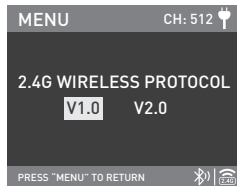
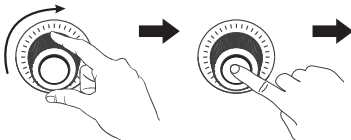
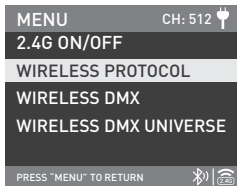

Rotate the right knob to WIRELESS PROTOCOL, and press the right knob to enter the next menu.

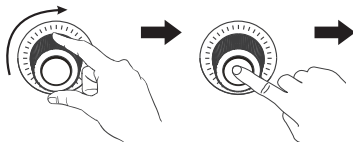
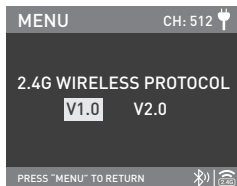

Rotate the right knob to select V1.0 or V2.0, and press the right knob to set.

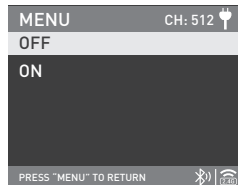
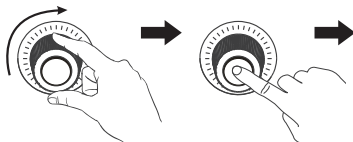
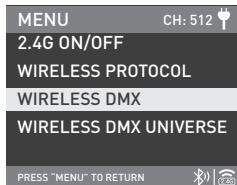

Rotate the right knob to WIRELESS DMX, and press the right knob to enter the next menu.

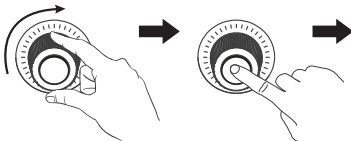
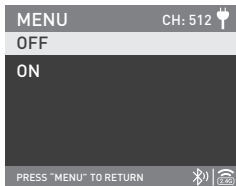

Rotate the right knob to select ON or OFF, and press the right knob to set.
 When WIRELESS DMX is on, the WIRELESS DMX UNIVERSE can be adjusted. While the remote controller or transmitter box can't be used to control the fixture.

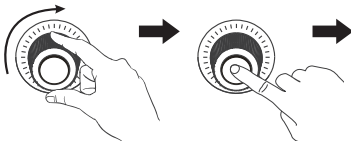
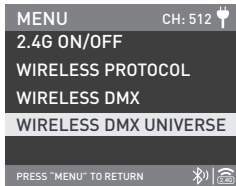

Rotate the right knob to WIRELESS DMX UNIVERSE, and press the right knob to enter the next menu.

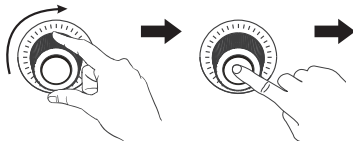
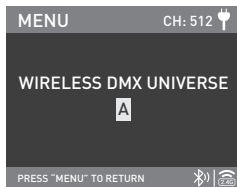

Rotate the right knob to select the needed universe, and press the right knob to set.

4.3 All Wireless On/Off

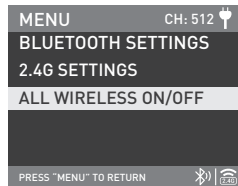
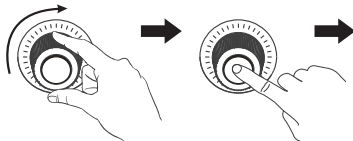
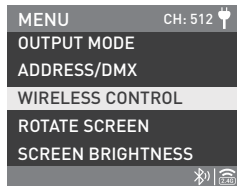

Rotate the right knob to WIRELESS CONTROL, and press the right knob to enter the secondary menu.

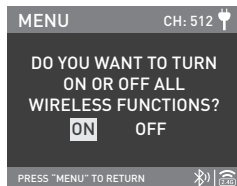
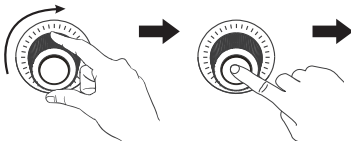
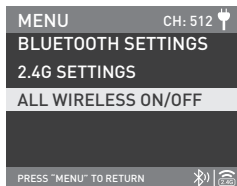

Rotate the right knob to ALL WIRELESS ON/OFF, and press the right knob to enter the tertiary menu.

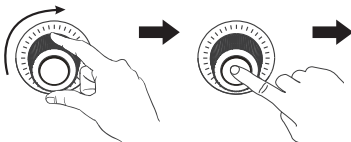
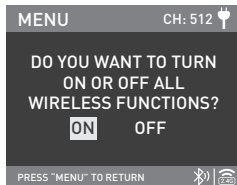

Rotate the right knob to select ON or OFF, and press the right knob to set.

Operating Instructions

1. Make sure the control unit is off, connect with the fixture, and connect to mains electricity via the power cable or mount the battery, and turn on the power switch, the screen will display "NANLITE".

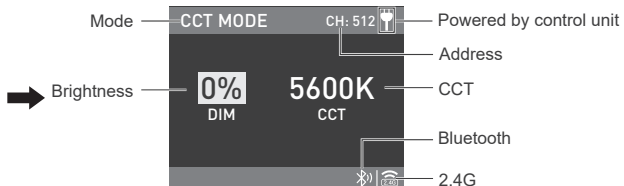

2. MODE Button: Press the MODE button to switch between CCT mode and EFFECT mode.

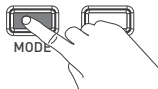
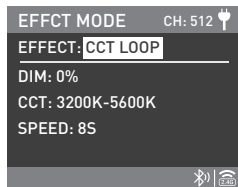
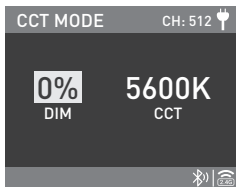

2.1 CCT Mode

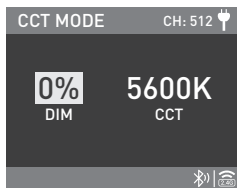

Left Knob



Right Knob

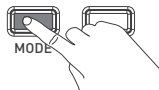

Press the MODE button to switch to CCT mode.

①DIM Setting: Rotate the left knob clockwise to increase the brightness, rotate anticlockwise to decrease, the percentage will be shown on the screen, DIM range: 0% - 100%.

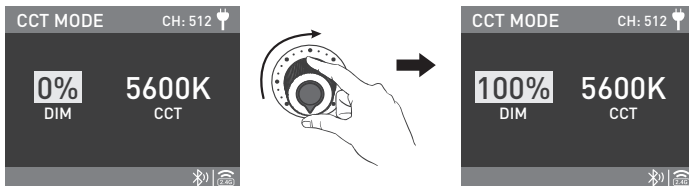

Note: In other modes, the DIM range is the same as that in CCT MODE. When the light function is not locked, in any mode, press the left knob to turn off the light, and the DIM percentage on the screen will be 0%. Press again to restore the fixture to its previous state. Press continuously to switch the light between on and off.

② CCT Setting: Rotate the right knob clockwise to increase the color temperature, rotate anticlockwise to decrease, the CCT value will be shown on the screen, CCT range: 2700K-6500K.

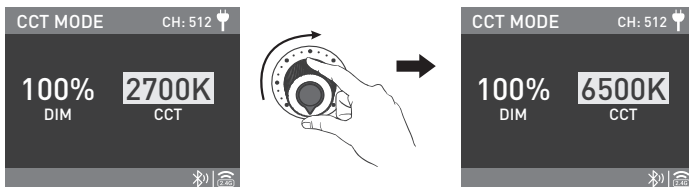

Note: In other modes, the CCT range is the same as that in CCT MODE. Press the right knob to promptly switch among: 2700K, 3200K, 4300K, 5600K and 6500K, which can be selected in a loop.

2.2 EFFECT Mode

PavoSlim 60B has built-in effects including CCT LOOP, INT LOOP, FLASH, PULSE, STORM AUTO, STORM MANUAL, TV, PAPARAZZI, CANDLE/FIRE, BAD BULB, FIREWORK, EXPLOSION AUTO, EXPLOSION MANUAL and WELDING.

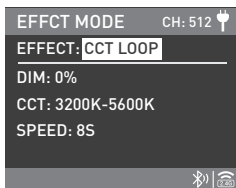

Left Knob



Right Knob

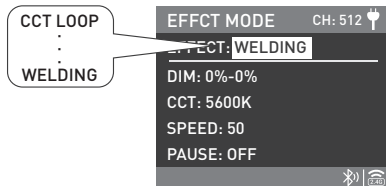
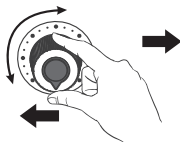
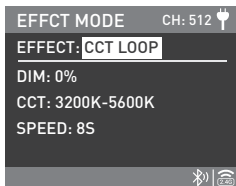
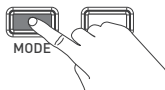

Rotate the left knob to select the needed effect, which can be selected in a loop.

① CCT LOOP

Rotate the right knob to select DIM, CCT or SPEED (range: 2s-30s), and rotate the left knob to set the corresponding parameters.

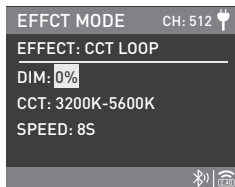
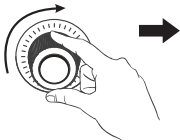
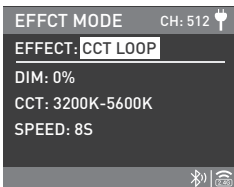

Rotate the right knob to select DIM, CCT or SPEED.

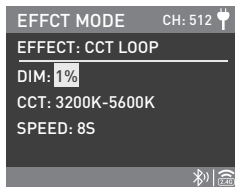
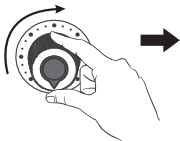
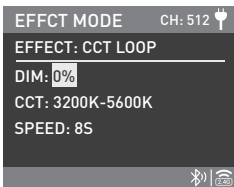

Rotate the left knob to set the corresponding parameters.

② INT LOOP

Rotate the right knob to select DIM, CCT or SPEED (range: 2s-30s), and rotate the left knob to set the corresponding parameters.

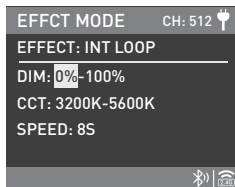
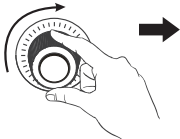
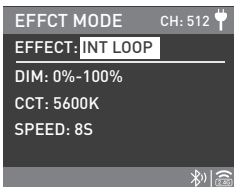

Rotate the right knob to select DIM, CCT or SPEED.

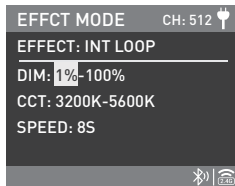
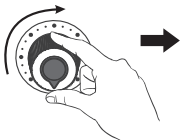
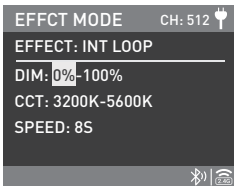

Rotate the left knob to set the corresponding parameters.

③ FLASH

Rotate the right knob to select DIM, CCT, INTERVALS (range: 0.1s-10.0s) or FLASH (range: 0% -100%), and rotate the left knob to set the corresponding parameters.

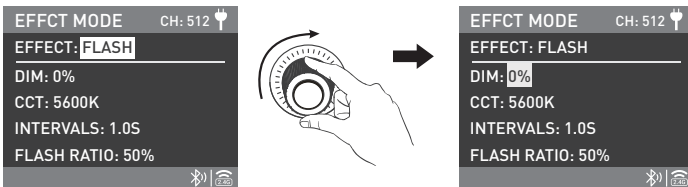

Rotate the right knob to select DIM, CCT, INTERVALS or FLASH RATIO.

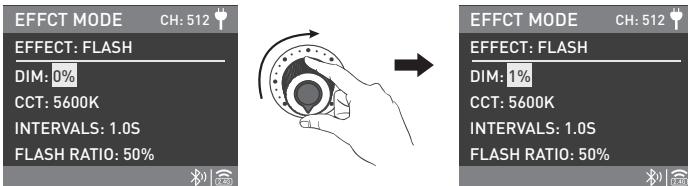

Rotate the left knob to set the corresponding parameters.

④ PULSE

Rotate the right knob to select DIM, CCT or PULSES/MIN (range: 1-240), and rotate the left knob to set the corresponding parameters.

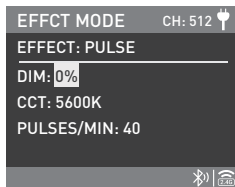
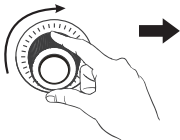
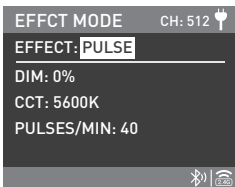

Rotate the right knob to select DIM, CCT or PULSES/MIN.

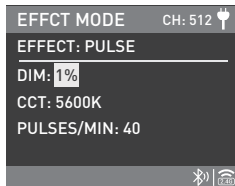
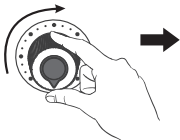
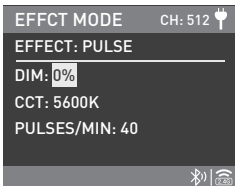

Rotate the left knob to set the corresponding parameters.

⑤ STORM AUTO

Rotate the right knob to select DIM, CCT or INTERVAL RANGE (range: 1s-60s) , and rotate the left knob to set the corresponding parameters.

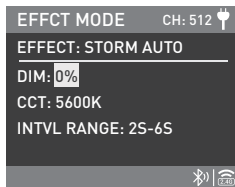
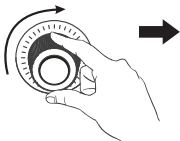
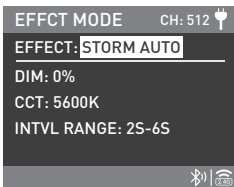

Rotate the right knob to select DIM, CCT or INTERVAL RANGE.

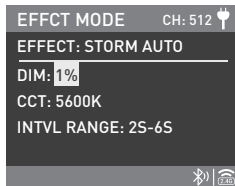
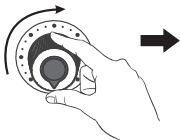
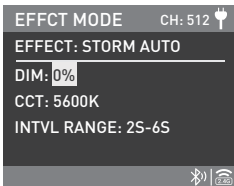

Rotate the left knob to set the corresponding parameters.

⑥ STORM MANUAL

Rotate the right knob to select DIM or CCT, and rotate the left knob to set the corresponding parameters, press the right knob to trigger the storm effect.

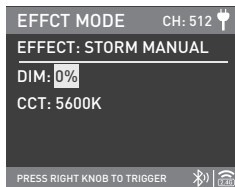
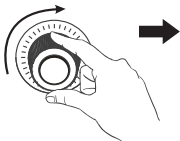
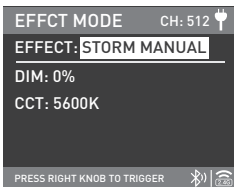

Rotate the right knob to select DIM or CCT.

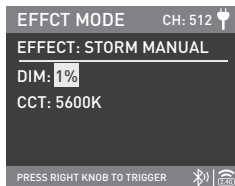
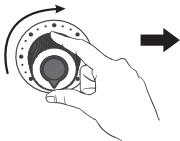
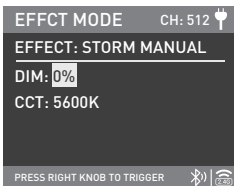

Rotate the left knob to set the corresponding parameters.

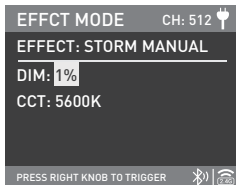

Press the right knob to trigger the storm effect.

TV

Rotate the right knob to select DIM, CCT, CCT SHIFT (range: 0K-3000K) or SPEED (range: 1-100), and rotate the left knob to set the corresponding parameters.

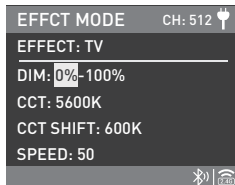
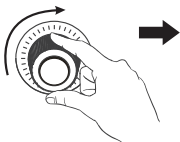
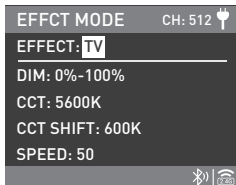

Rotate the right knob to select DIM, CCT, CCT SHIFT or SPEED.

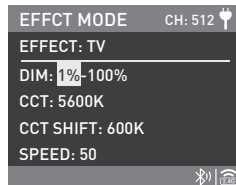
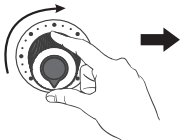
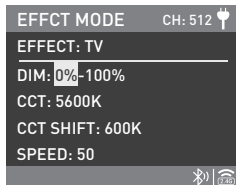

Rotate the left knob to set the corresponding parameters.

ⓈPAPARAZZI

Rotate the right knob to select DIM, CCT or SPEED (range:1-100), and rotate the left knob to set the corresponding parameters.

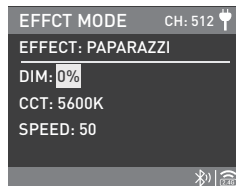
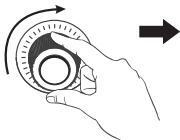
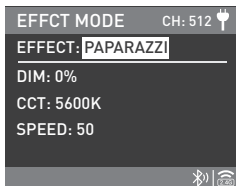

Rotate the right knob to select DIM, CCT or SPEED.

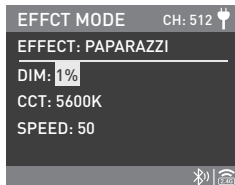
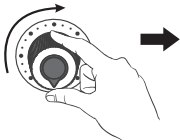
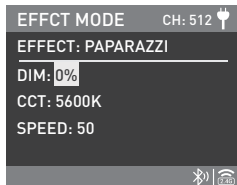

Rotate the left knob to set the corresponding parameters.

Ⓒ CANDLE/FIRE

Rotate the right knob to select DIM, CCT, CCT SHIFT (range: 0K-3000K) or SPEED (range: 1-100), and rotate the left knob to set the corresponding parameters.

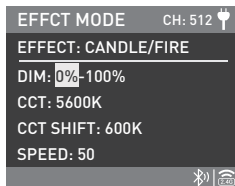
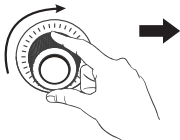
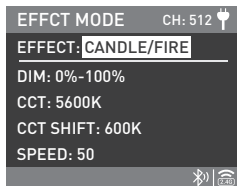

Rotate the right knob to select DIM, CCT, CCT SHIFT or SPEED.

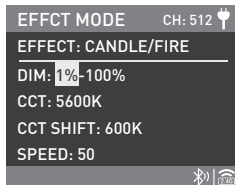
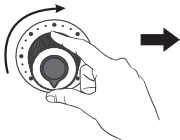
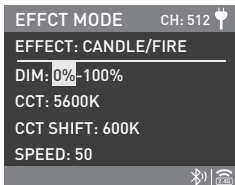

Rotate the left knob to set the corresponding parameters.

⑩BAD BULB

Rotate the right knob to select DIM, CCT, INTENSITY (range: 1-100) or SPEED (range: 1-100), and rotate the left knob to set the corresponding parameters.

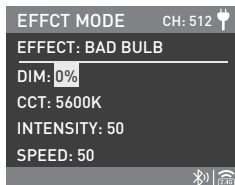
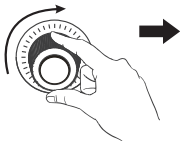
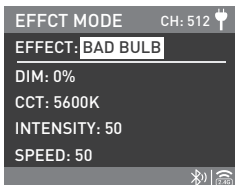

Rotate the right knob to select DIM, CCT, INTENSITY or SPEED.

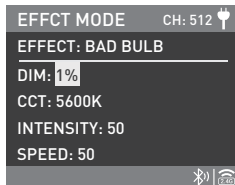
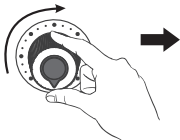
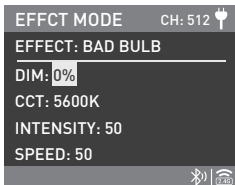

Rotate the left knob to set the corresponding parameters.

⑩ FIREWORK

Rotate the right knob to select DIM, CCT, SPEED (range: 1-100) or DECAY (range: 1-100), and rotate the left knob to set the corresponding parameters.

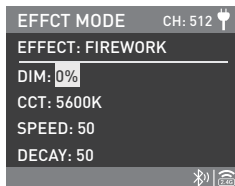
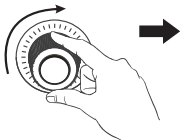
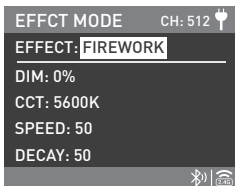

Rotate the right knob to select DIM, CCT, SPEED or DECAY.

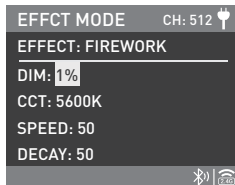
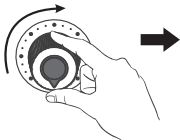
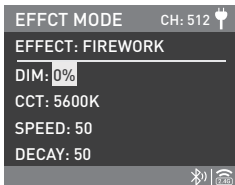

Rotate the left knob to set the corresponding parameters.

⊗EXPLOSION AUTO

Rotate the right knob to select DIM, CCT, SPEED (range: 1-100) or DECAY (range: 1-100), and rotate the left knob to set the corresponding parameters.

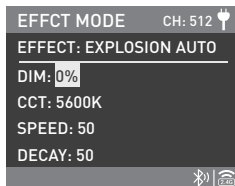
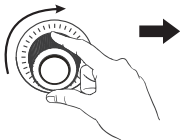
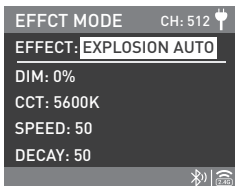

Rotate the right knob to select DIM, CCT, SPEED or DECAY.

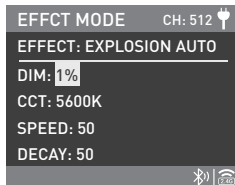
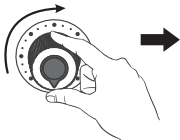
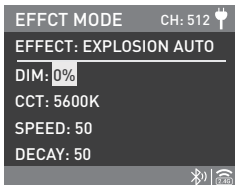

Rotate the left knob to set the corresponding parameters.

⑬ EXPLOSION MANUAL

Rotate the right knob to select DIM, CCT or DECAY (range: 1-100), and rotate the left knob to set the corresponding parameters, press the right knob to trigger the explosion effect.

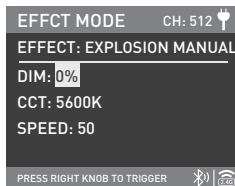
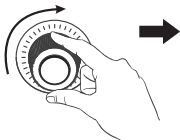
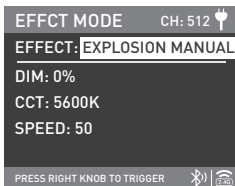

Rotate the right knob to select DIM, CCT or DECAY.

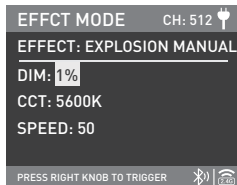
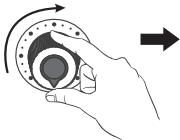
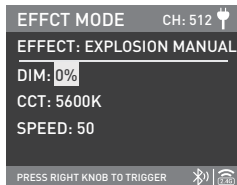

Rotate the left knob to set the corresponding parameters.

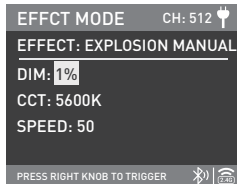

Press the right knob to trigger the explosion effect.

ⓈWELDING

Rotate the right knob to select DIM, CCT, SPEED (range: 1–100) or PAUSE, and rotate the left knob to set the corresponding parameters.

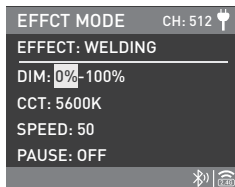
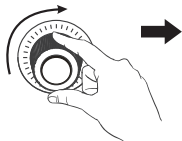
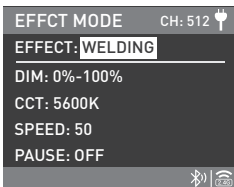

Rotate the right knob to select DIM, CCT, SPEED or PAUSE.

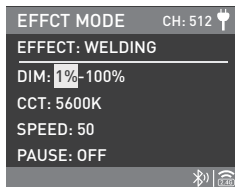
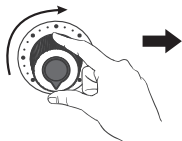
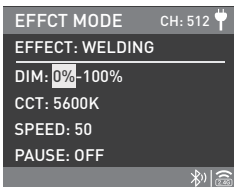

Rotate the left knob to set the corresponding parameters.

Lighting effects and additional functionality will be probably updated with the later firmware version.

Detailed information is subject to the instruction of firmware function.

3. MENU Button: Press the MENU button to enter the interface of menu.

Rotate the right knob to select the options, press the right knob to enter the secondary menu, and rotate the right knob to select the corresponding parameters, then press the right knob to set. Press the MENU button to return to the previous menu.

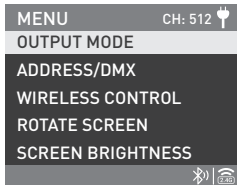

Left Knob



Right Knob

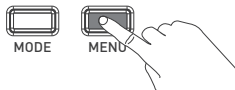

3.1 OUTPUT MODE

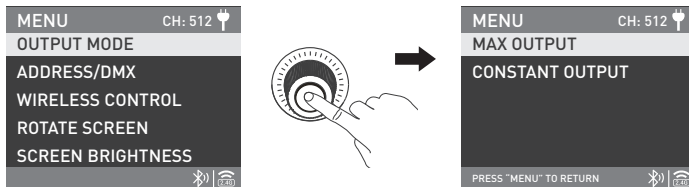

Rotate the right knob to OUTPUT MODE, and press the right knob to enter the secondary menu.

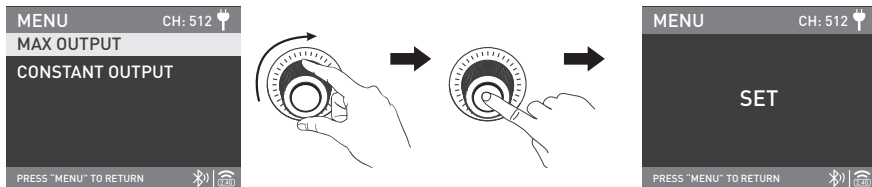

Rotate the right knob to select MAX OUTPUT or CONSTANT OUTPUT, and press the right knob to set.

3.2 ADDRESS/DMX

For detailed operations please refer to P15.

3.3 WIRELESS CONTROL

For detailed operations please refer to P24.

3.4 ROTATE SCREEN

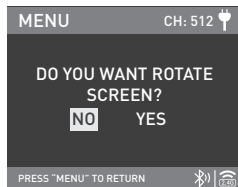
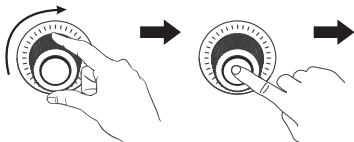
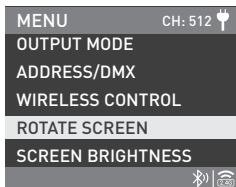

Rotate the right knob to ROTATE SCREEN, and press the right knob to enter the secondary menu.

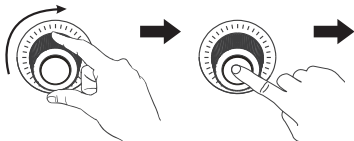
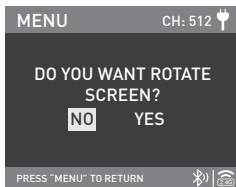

Rotate the right knob to select YES or NO, and press the right knob to set.

3.5 SCREEN BRIGHTNESS

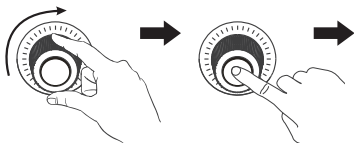
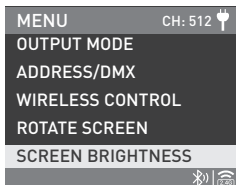

Rotate the right knob to **SCREEN BRIGHTNESS**, and press the right knob to enter the secondary menu.

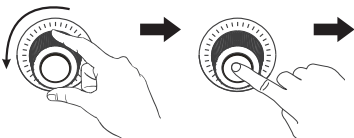
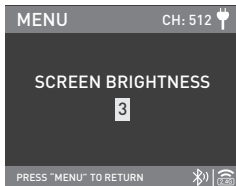

Rotate the right knob to select the screen brightness, and press the right knob to set.

3.6 BUTTON BACKLIGHT

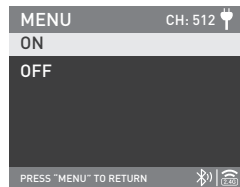
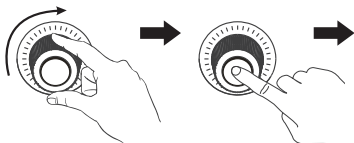
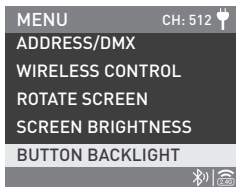

Rotate the right knob to **BUTTON BACKLIGHT**, and press the right knob to enter the secondary menu.

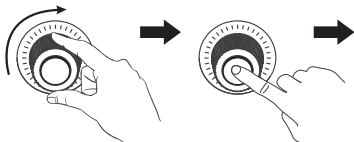
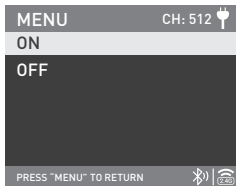

Rotate the right knob to select **ON** or **OFF**, and press the right knob to set.

3.7 LANGUAGE

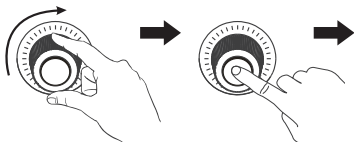
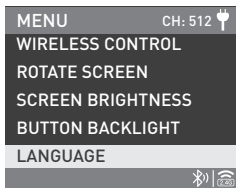

Rotate the right knob to the LANGUAGE, and press the right knob to enter the secondary menu.

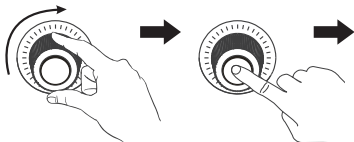

Rotate the right knob to ENGLISH or 简体中文, and press the right knob to set.

3.8 FIRMWARE UPDATE

Put the two firmware files into the root directory of the USB drive (ensure the firmware versions match), and insert the USB drive to the USB port.

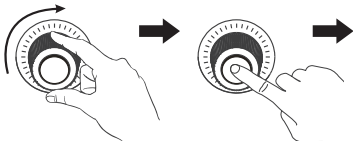
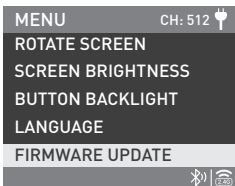

Rotate the right knob to FIRMWARE UPDATE, press the right knob to enter the interface to search for the firmware files.

Note:

- ① Please do not rename the firmware files.
- ② Ensure the USB drive is formatted to FAT, FAT32 or exFAT.
- ③ If prompted that "NO FIRMWARE FOUND", please check whether the firmware files are correct, whether the firmware files are put in the root directory of the USB drive, or whether the USB drive format is FAT, FAT32 or exFAT.
- ④ If all the above steps are done and the firmware files still cannot be found, please format the USB drive again.
- ⑤ If the fixture still cannot identify the USB drive, please replace the USB drive.

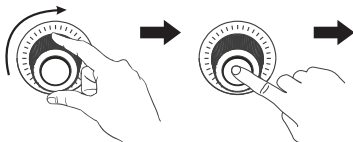
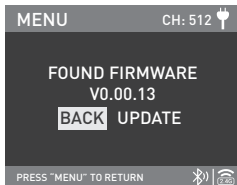

After firmware file is found, enter the firmware update interface, rotate the right knob to select UPDATE, and press the right knob to make update. After update, the light fixture will automatically restart.



3.9 RESET ALL SETTING

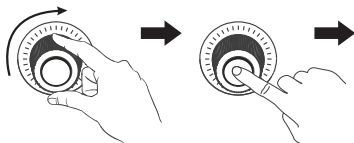
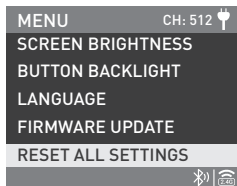

Rotate the right knob to **RESET ALL SETTINGS**, and press the right knob to enter the secondary menu.

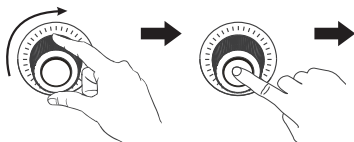
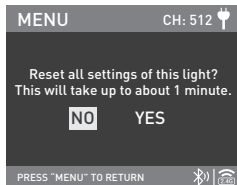

Rotate the right knob to select **YES** or **NO**, and press the right knob to set.

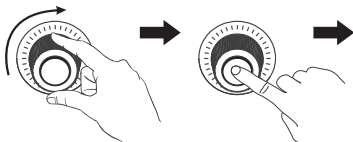
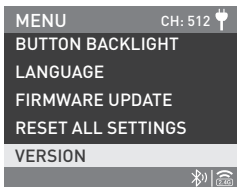

Rotate the right knob to VERSION, and press the right knob to check the current version.

4. When the fixture is not in use, please turn off the power switch.

General Fault Detection and Diagnosis

Fault Detection	Diagnosis
<p>The fixture won't boot up properly. Check whether the display screen is normal.</p>	<ol style="list-style-type: none"> 1. Please check whether the connection between control unit and fixture are loose if the display screen can work. 2. Please check whether the voltage is within the specified range or the connection cable is loose if the display screen can't work.
<p>The fixture can be operated manually, but DMX control is not working.</p>	<ol style="list-style-type: none"> 1. Please check whether the DMX address setting of the fixture is correct. 2. Please check whether the DMX cable is connected correctly and without damage.
<p>If the fault is not resolved after troubleshooting, please contact with the place of purchase.</p>	

Certification



Made in China

Please scan the QR code for more details.



DMX Reference Guide



Detailed User Manual



Nanlite Website



Nanlink App

This manual has been compiled according to the rigorous testing for Nanlite products. Product designs are subject to change without prior notice. The latest version of the manual for this product is downloadable at www.nanlite.com.

WWW.NANLITE.COM

NANLITE

📞 0754-85751187

✉ info@nanlite.com

☎ 0754-85300887

📍 Dongli Section, Highway 324, Chenghai, Shantou City, Guangdong Province, China